



## Smart Control Kit Installation Guide

Installation requires no special tools—you'll just need a screwdriver, stepladder and smartphone!

**Model V2**

**[adhguardianusa.com](http://adhguardianusa.com)**

**1-424-272-6998**

# Thank you for purchasing the beam Smart Control Kit!

Please read and follow all installation instructions. Homeowners should retain this guide for reference.

**TIP:** If you are a professional installer, setup within the beam Home app should be done using the homeowner's smartphone.

Date Installed: \_\_\_\_\_



**A**

**Controller**

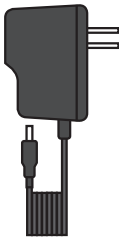

**B**

**Power  
adapter**



**C**

**Wireless door  
sensor**



**D**

**Opener  
cable**

# 1

## Download the app & begin setup

-  While inside your home, download the “**beam Home**” app from the App Store (iOS) or Google Play (Android).
- Open the app, and select “Setup Your beam.”
- Follow prompts within the app to verify the WiFi network you’d like your controller to connect to, and enter your network password.

**TIP:** Make sure you do not select a 5G network for setup (beam only connects to 2.4GHz networks).



## 2

### Power up the controller

- Locate the controller **A** and power adapter **B**. Plug the adapter into the DC IN port on the controller and a nearby power source.
- The controller's WiFi status light will blink orange to indicate it's ready for setup.

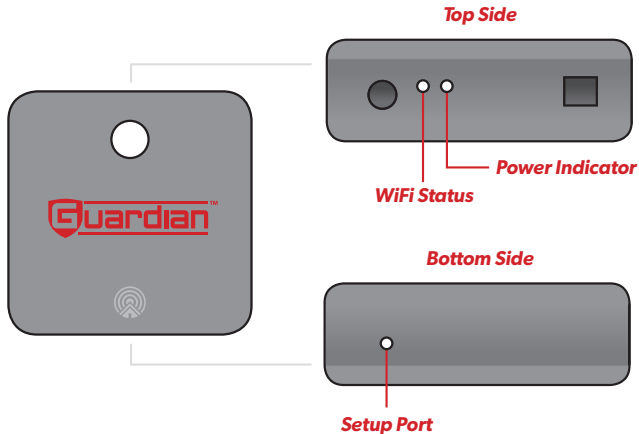

### 3

## Program the controller

- Follow prompts within the app, and when directed, press your phone screen tightly against the bottom setup port.

**TIP:** It may be helpful to dim the lights or cup your hand over your phone during programming to minimize light interference.

- If successful, the controller will beep and the WiFi status light will blink green. You'll then be prompted to create an account. (If not successful, the WiFi status light will blink red and you will be guided through setup again.)

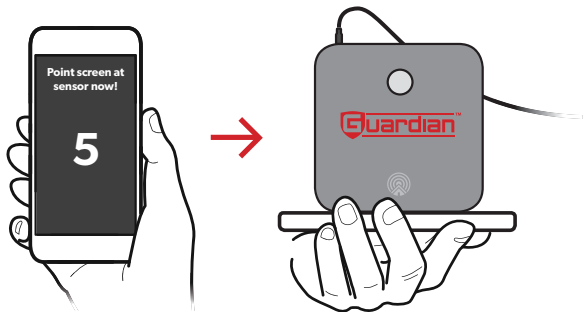

# 4

## Scan the wireless door sensor code

- Locate the wireless door sensor **C** and follow prompts within the app to scan the code (found on the back of the sensor).
- Enter a name to identify your door.
- Unplug the controller and head out to the garage!

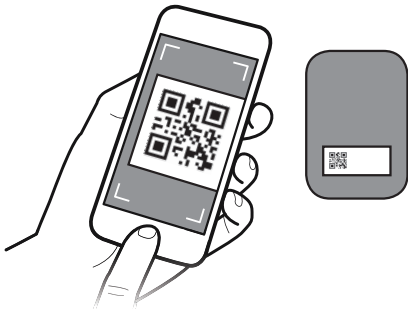

# 5

## Mount the wireless door sensor

- Clean and wipe dry an area at the top of your garage door's interior panel.
- Remove the battery tab from the back of the wireless door sensor **C** and mount to the cleaned area of the garage door using the adhesive Velcro strip.

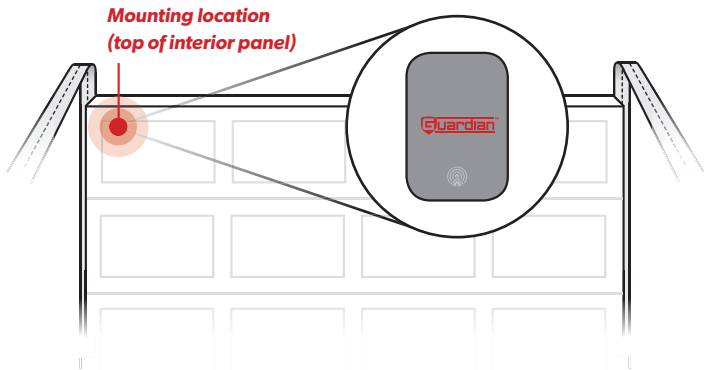

## 6

## Mount the controller

- Locate the controller **A** and power adapter **B**, and grab your stepladder.
- Clean and wipe dry your selected mounting location, either on the garage door opener or a nearby surface. Mount using the adhesive strip on the back of the controller.

**TIP:** The controller should be mounted within 3 feet of the garage door opener and within 6 feet of a power source.

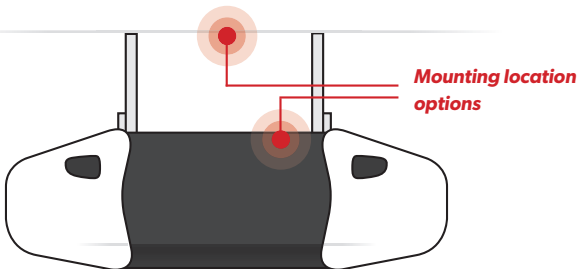



# 7

## Connect the opener cable to the controller

- Locate the opener cable **D**.
- Plug the black connector into the opener port on the top side of the controller.

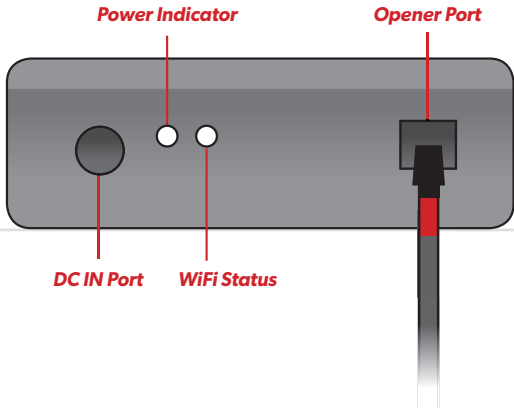

## 8

## Connect the controller to the garage door opener

- Unplug your garage door opener.
- Using your screwdriver, connect the other end of the opener cable **D** to your garage door opener push button terminals. If there are already other wires present, they can be spliced together with the opener cable to share the same terminals.



**TIP:** View sample connection diagrams for other garage door opener makes and models at: [adhguardianusa.com/install-beam](https://adhguardianusa.com/install-beam)

*Sample diagram of Guardian terminals*

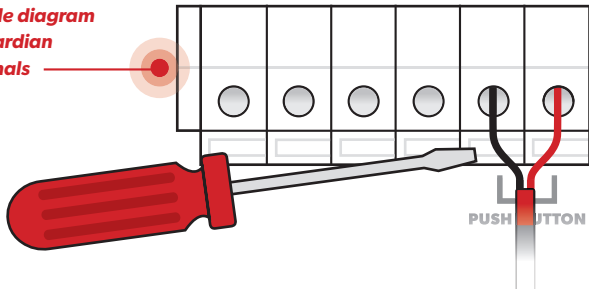

## 9 Power up the controller & opener

- Plug the power adapter **B** into the DC IN port on the controller **A** and a nearby power source.
- Plug your garage door opener back in. All done!

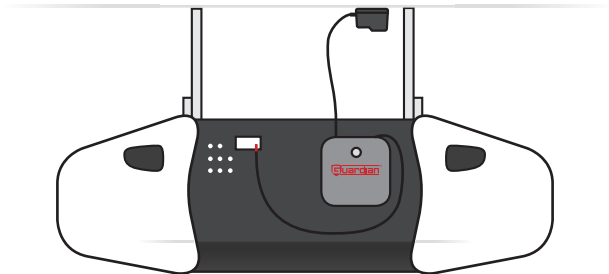

## Get the most from your beam Smart Control Kit!

- **Share access with others** – Invite friends and family within the app. No need to share your code or buy additional remotes.
- **Explore integrations** – beam plays well with others, from IFTTT to Amazon Alexa.
- **Register your Smart Control Kit** – Register online at: [adguardianusa.com/warranty-information](https://adguardianusa.com/warranty-information)



### Warning:

To reduce the risk of injury to persons:

- Use this Smart Control Kit only with Residential Sectional Garage doors.
- Do not enable this device on a one-piece or swinging garage door.
- Do not use this device on garage door openers made before 1993 without a working photo-eye safety system.

©2018, ADH Guardian USA LLC. Amazon, Alexa and all related logos are trademarks of Amazon.com, Inc. or its affiliates.

Guardian Access & Door Hardware | 122 Penn Street | El Segundo, CA 90245

